

Oggetto: DISEGNO ESECUTIVO (SCHEMA) GABBIANO 800

Committente: .

Data: .

Scala: .

Cod. file

GABBIANO 800

Località: .

**QUADRO D'INSIEME**

PIANTA

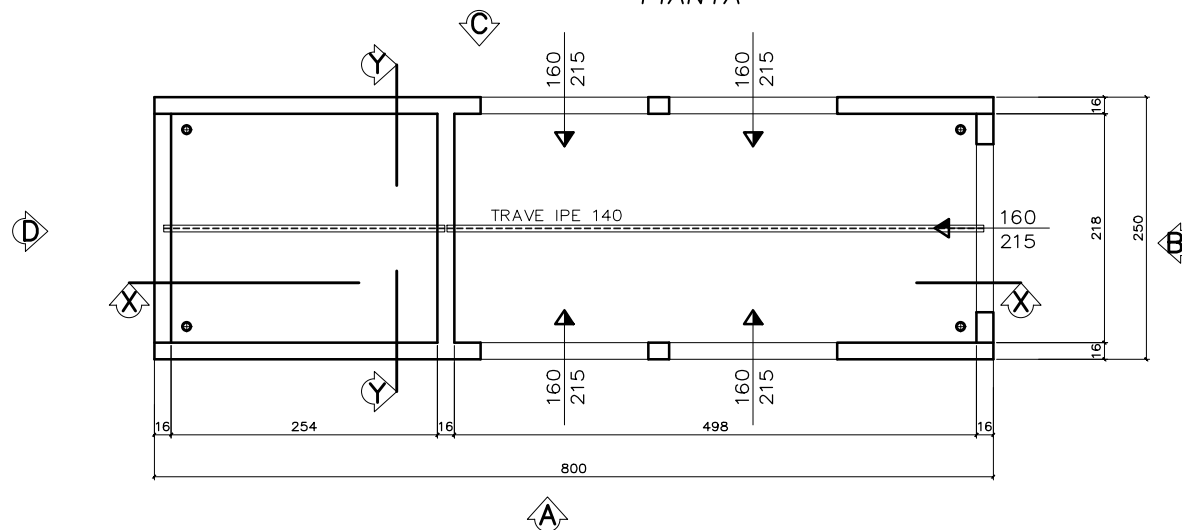

SEZIONE X-X

SEZIONE Y-Y

LASTRE ONDULATE  
DI COPERTURA  
IN FIBROCEMENTO

ESEMPIO FORATURE  
PER PASSAGGIO  
CAVIDOTTI

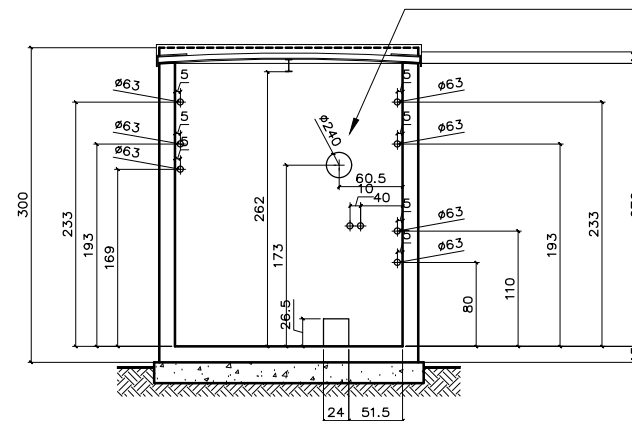
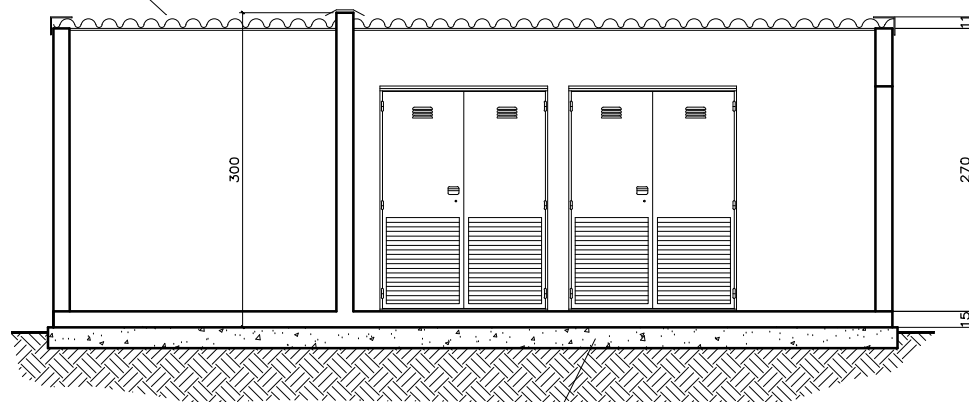

PLATEA IN CLS

PROSPETTO A

BANDINELLA PERIMETRALE  
IN LAMIERA PREVERNICIATA

N. 5 PORTE IN LAMIERA  
PREVERNICIATA  
DIM. 160X215 AREAZ. INF.  
SERRATURA HB TIPO CISA

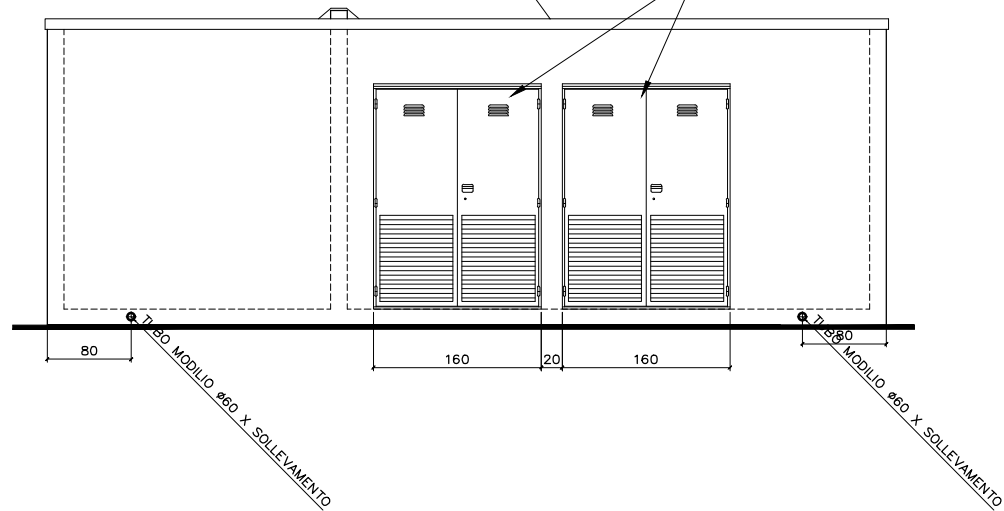

PROSPETTO B

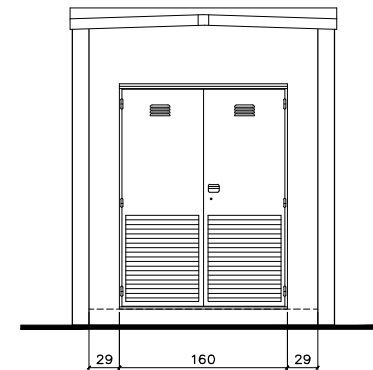

PROSPETTO C

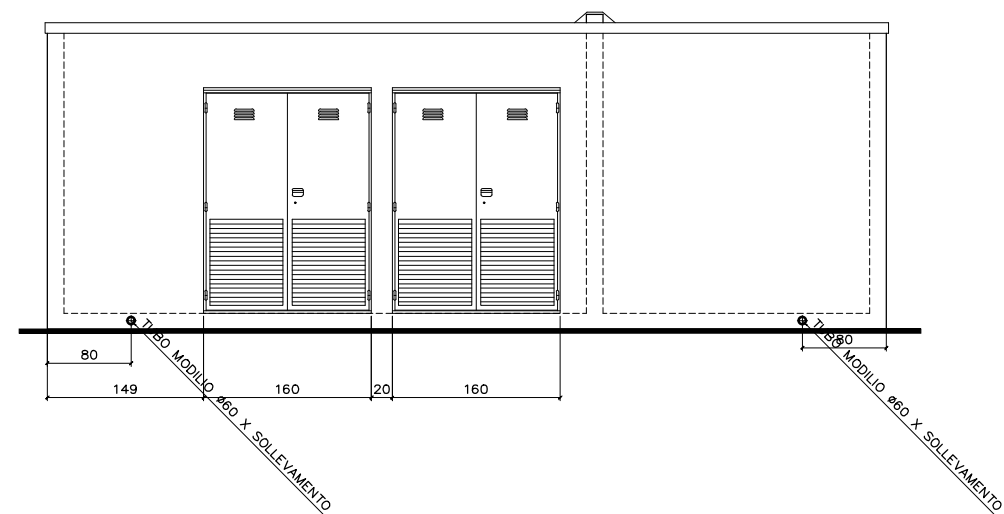

PROSPETTO D

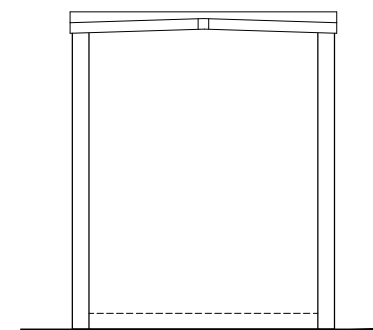

Oggetto: DISEGNO ESECUTIVO (SCHEMA) GABBIANO 800

Committente: .

Data:

Scala:

Cod. file

Località: .

GABBIANO 800

**PIANTA PLATEA DI FONDAZIONE**

PIANTA PLATEA DI FONDAZIONE

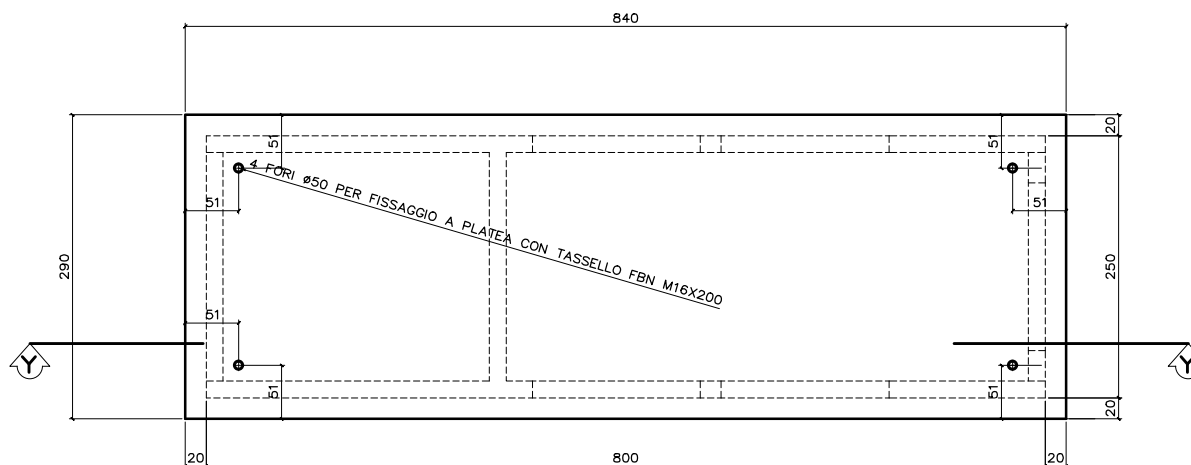

SEZIONE Y-Y

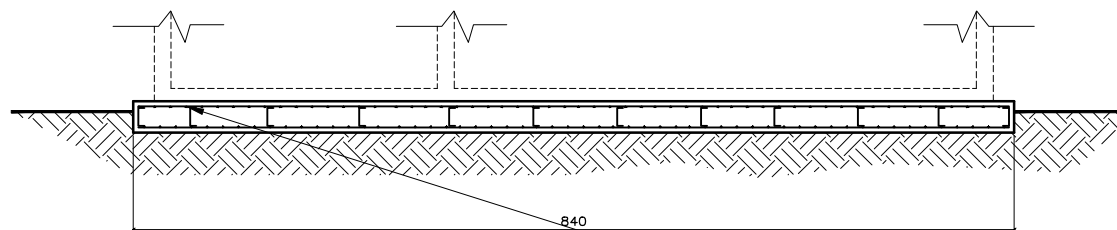

CARICHI IN FONDAZIONE t.26 = ql. 260 (escluso impianti)  
PLATEA DI FONDAZIONE A CARICO DEL CLIENTE