

Oggetto: DISEGNO ESECUTIVO (SCHEMA) CABINA MONOBLOCCO

| | | | |
|--------------|-------------------|--------|-----------|
| Committente: | Data: 28/05/18 | Scala: | Cod. file |
| Località: | | | |

PIANTA PROSPETTI E SEZIONI (PAG. 1,2)

PIANTA

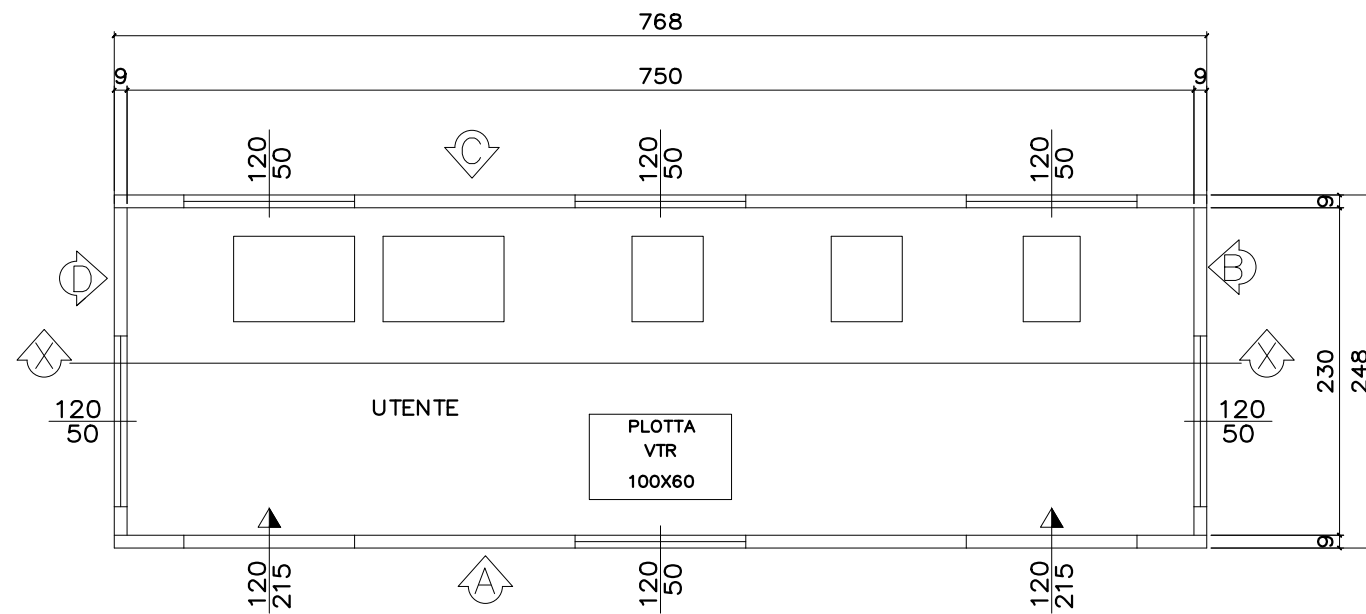

PIANTA COPERTURA SP. cm. 9

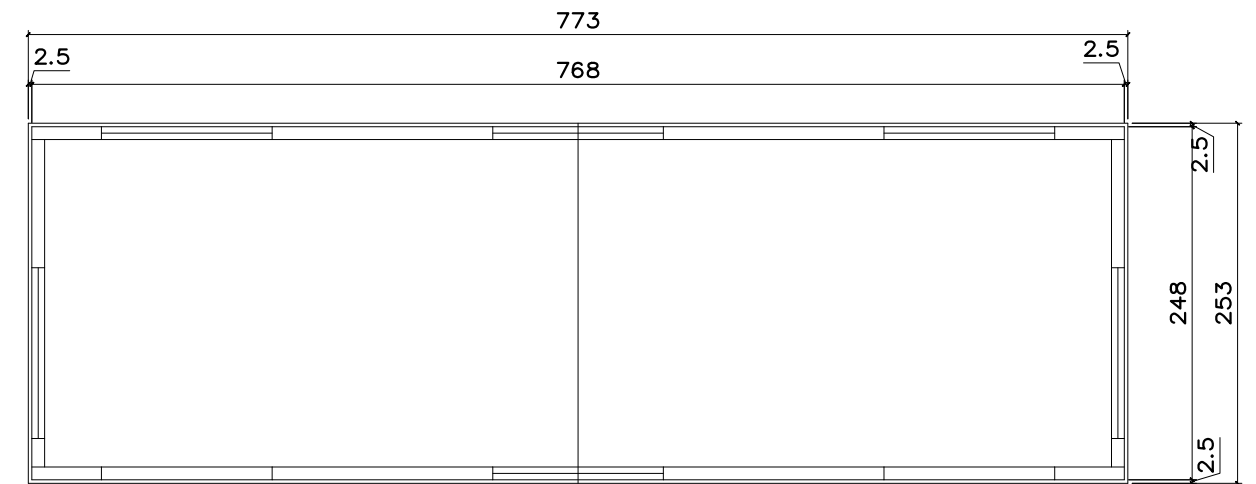

sezione X-X

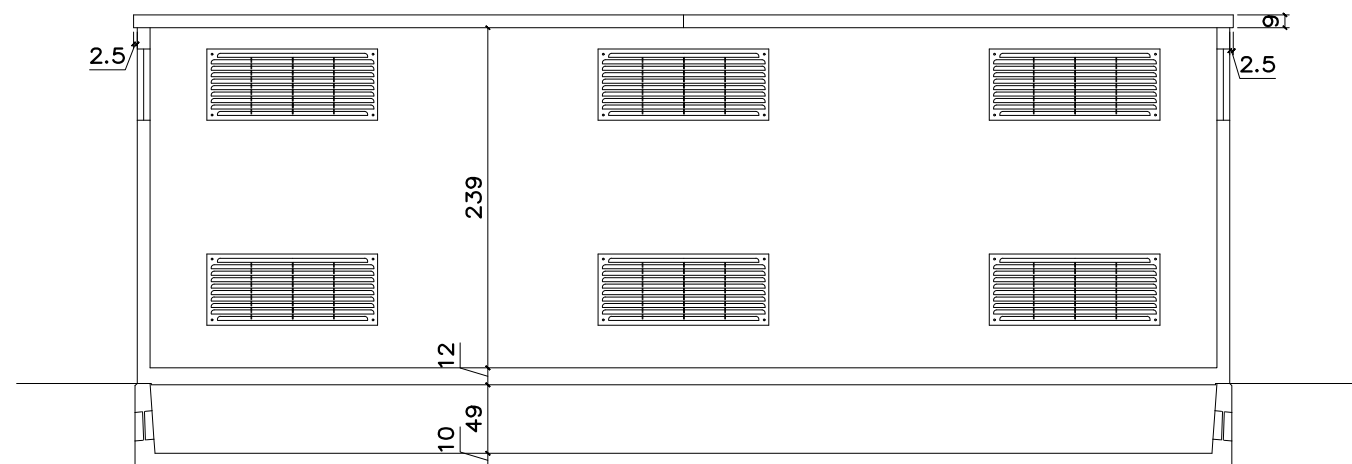

Oggetto: DISEGNO ESECUTIVO (SCHEMA) CABINA MONOBLOCCO

| | | | |
|--------------|----------|--------|-----------|
| Committente: | Data: | Scala: | Cod. file |
| Località: | 28/05/18 | | |

PIANTA PROSPETTI E SEZIONI (PAG. 1,2)

VISTA LATO A

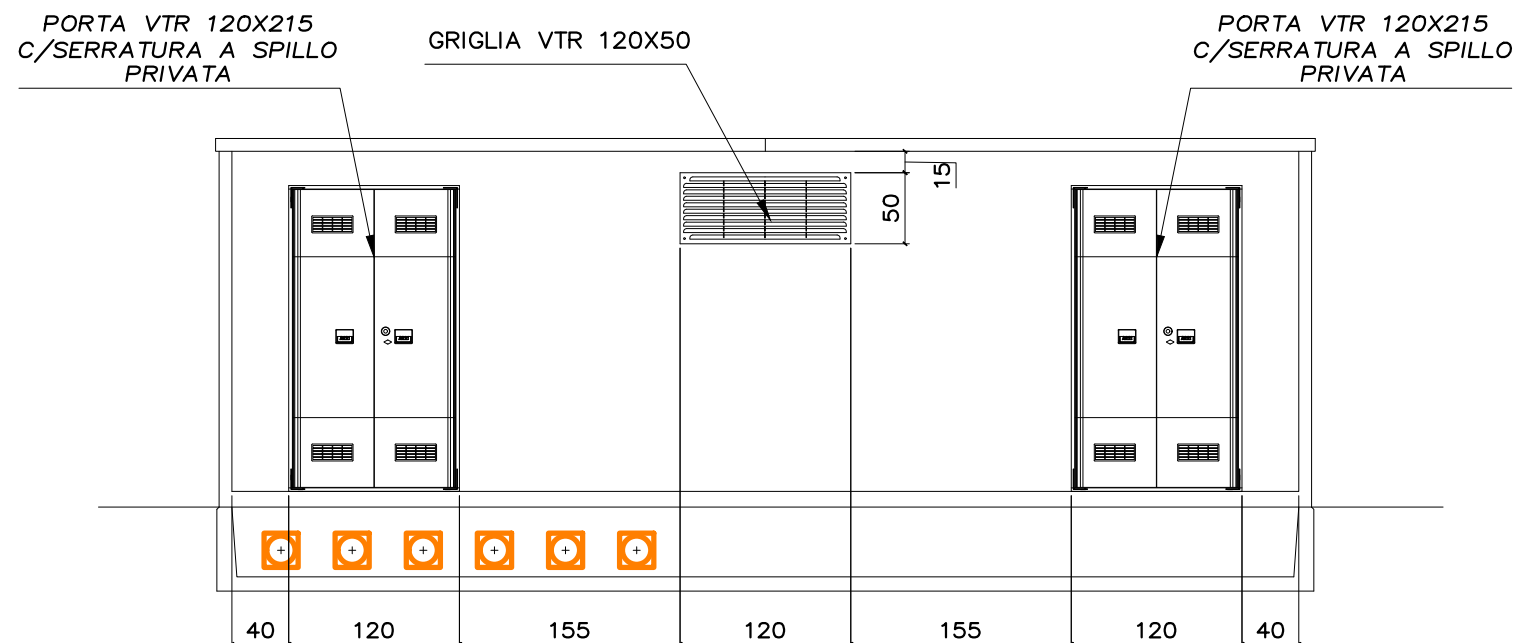

VISTA LATO B

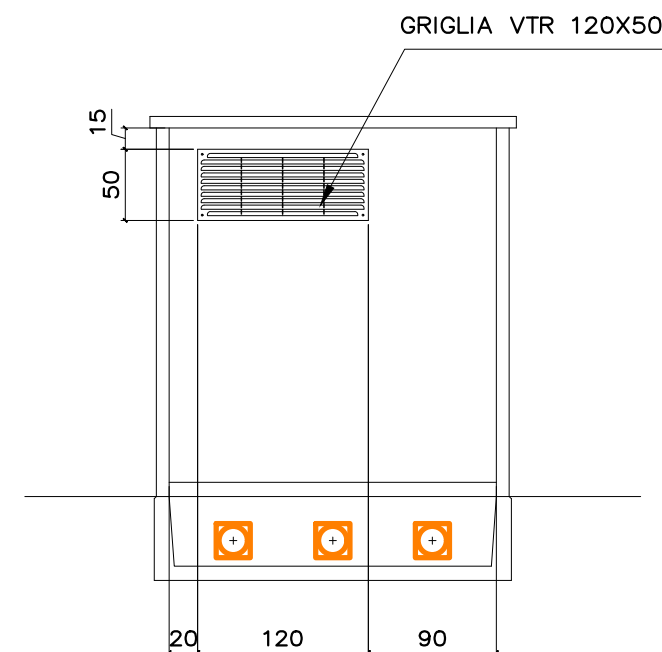

VISTA LATO C

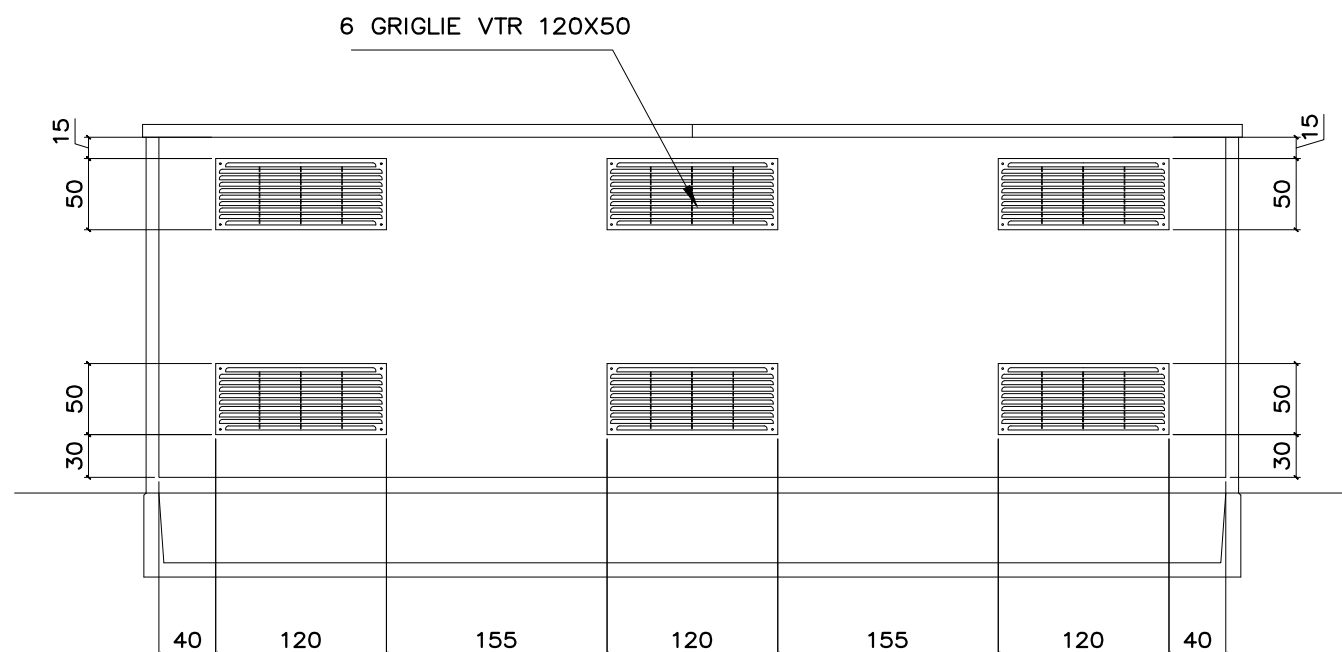

VISTA LATO D

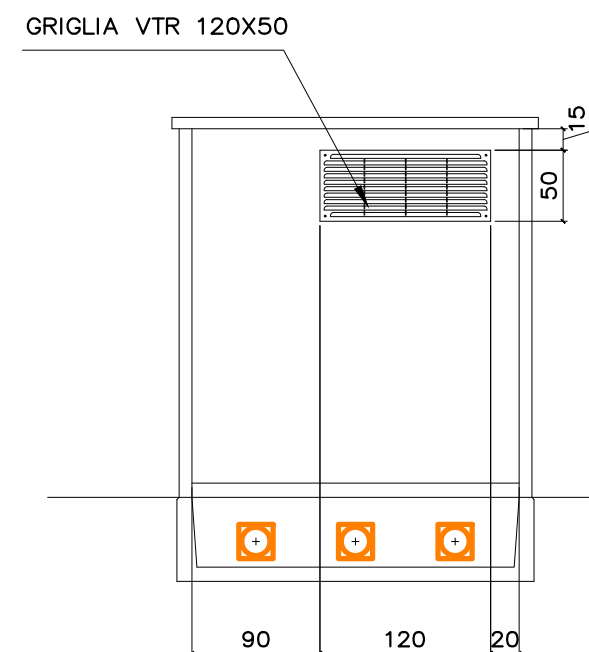

Oggetto: DISEGNO ESECUTIVO (SCHEMA) CABINA MONOBLOCCO

| | | | |
|--------------|-------------------|--------|-----------|
| Committente: | Data: 28/05/18 | Scala: | Cod. file |
| Località: | | | |

PIANTA ASOLATURE PAVIMENTO

LEGENDA:

